



ELIZABETH

125_RL_6
Assembly Instructions

5 STEPS

RL 6

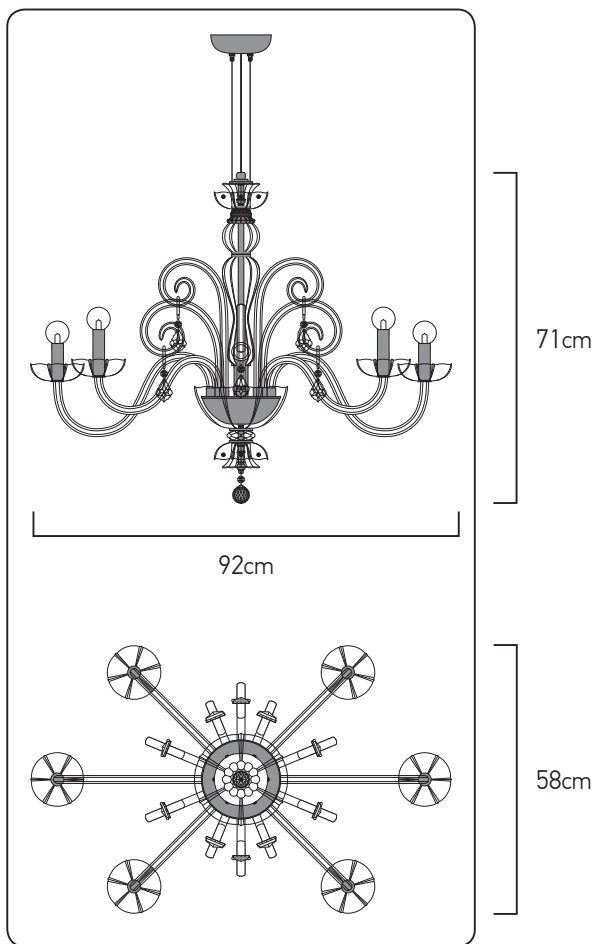

ELIZABETH_RL 6

parts_components

N°1 x 1

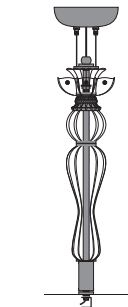

N°2 x 2



N°3 x 4

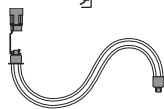

N°4 x 4

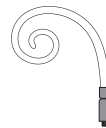

N°5 x 4

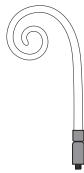

N°6 x 2

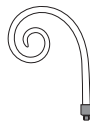

N°7 x 2



N°8 x 4



N°9 x 6



N°10 x 1



A x 6



B x 4



C x 1



reference

lamps

lamp Watt Max

A.C

125/RL 6

6 x E14

42 Watt

230V - 50Hz



ΗΜΕΡΟΜΗΝΙΑ ΕΛΕΓΧΟΥ
TESTING DATE

..... / /

ΥΠΟΓΡΑΦΗ ΕΛΕΓΚΤΗ
TEST OPERATOR

.....



DO NOT ASSEMBLE ANY GLASS PARTS THAT PRESENT CRACKS OR ANY OTHER DAMAGED CAUSED BY CARRIAGE OR WRONG PLACEMENT. A CAREFUL CHECK IS SUGGESTED. CLEAN WITH SOFT CLOTH OR MILD RISING AGENT WITH LOW TEMPERATURE WATER.
ΜΗ ΣΥΝΑΡΜΟΛΟΓΕΙΤΕ ΓΥΑΛΙΝΑ ΜΕΡΗ ΠΟΥ ΦΕΡΟΥΝ ΡΩΓΜΕΣ Ή ΑΛΛΕΣ ΖΗΜΙΕΣ ΑΠΟ ΜΕΤΑΦΟΡΑ Ή ΛΑΘΟΣ ΤΟΠΟΘΕΤΗΣΗ. ΚΑΘΑΡΙΣΤΕ ΜΕ ΜΑΛΛΑΚΟ ΠΑΝΙ Ή ΜΕ ΗΠΙΟ ΚΑΘΑΡΙΣΤΙΚΟ ΜΕ ΝΕΡΟ ΣΕ ΧΑΜΗΛΗ ΘΕΡΜΟΚΡΑΣΙΑ.

THIS DESIGN IS PROPERTY OF GRANDO LUCE AND IT IS FORBIDDEN TO COPY ANY PART OF THE DESIGN
ΑΥΤΟ ΤΟ ΣΧΕΔΙΟ ΕΙΝΑΙ ΙΔΙΟΚΤΗΣΙΑ ΤΗΣ GRANDO LUCE ΚΑΙ ΑΠΑΓΟΡΕΥΕΤΑΙ ΑΥΣΤΗΡΩΣ Η ΑΝΤΙΓΡΑΦΗ ΟΛΟΥ Ή ΜΕΡΟΥΣ ΑΥΤΟΥ

STEP_1

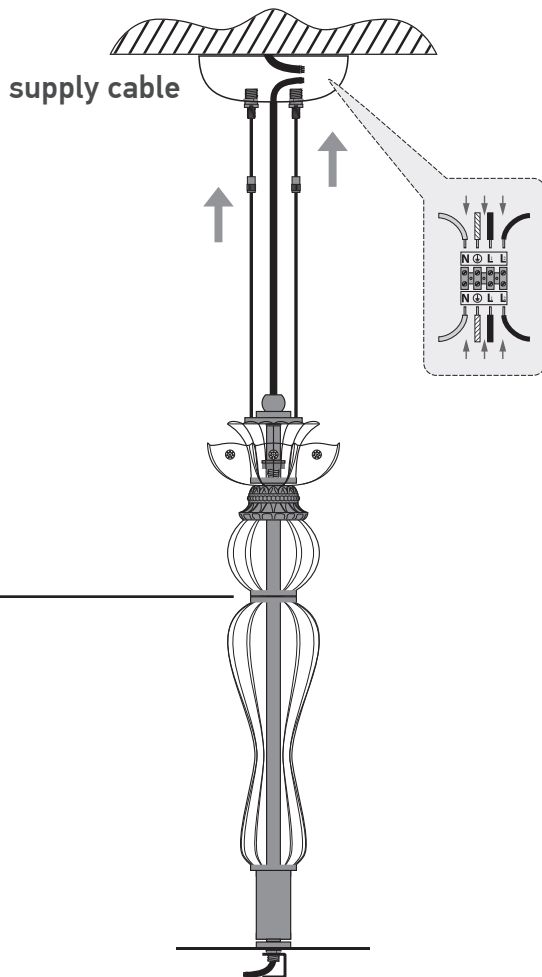

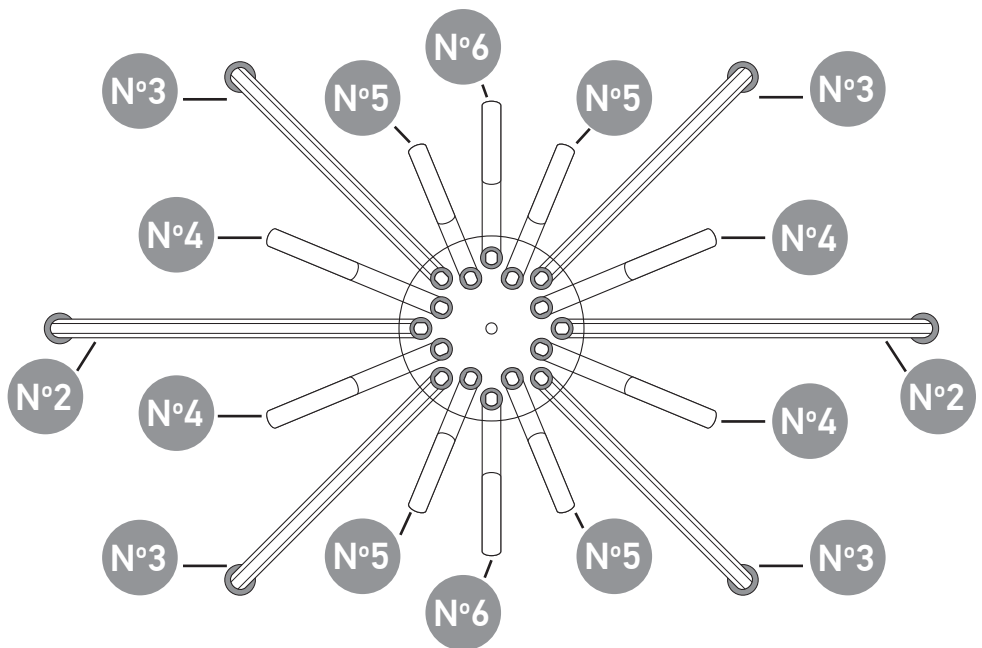
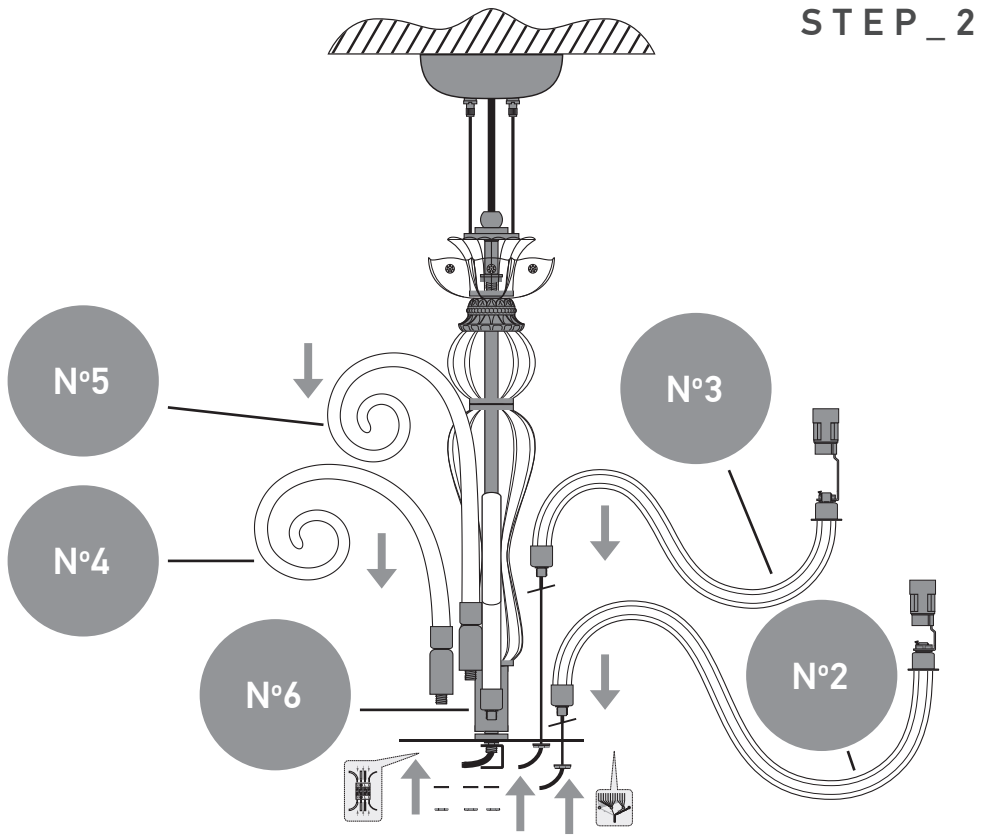

STEP_3

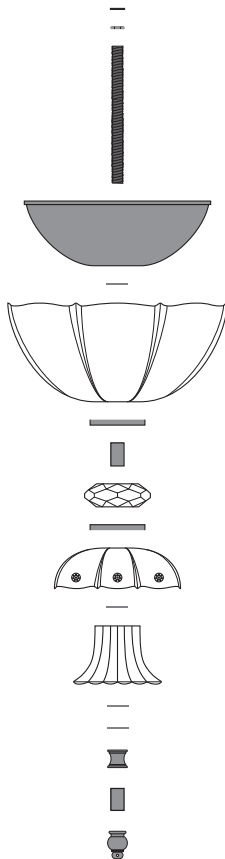
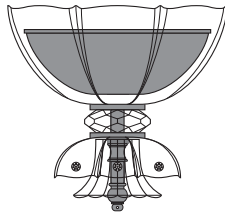

STEP_4

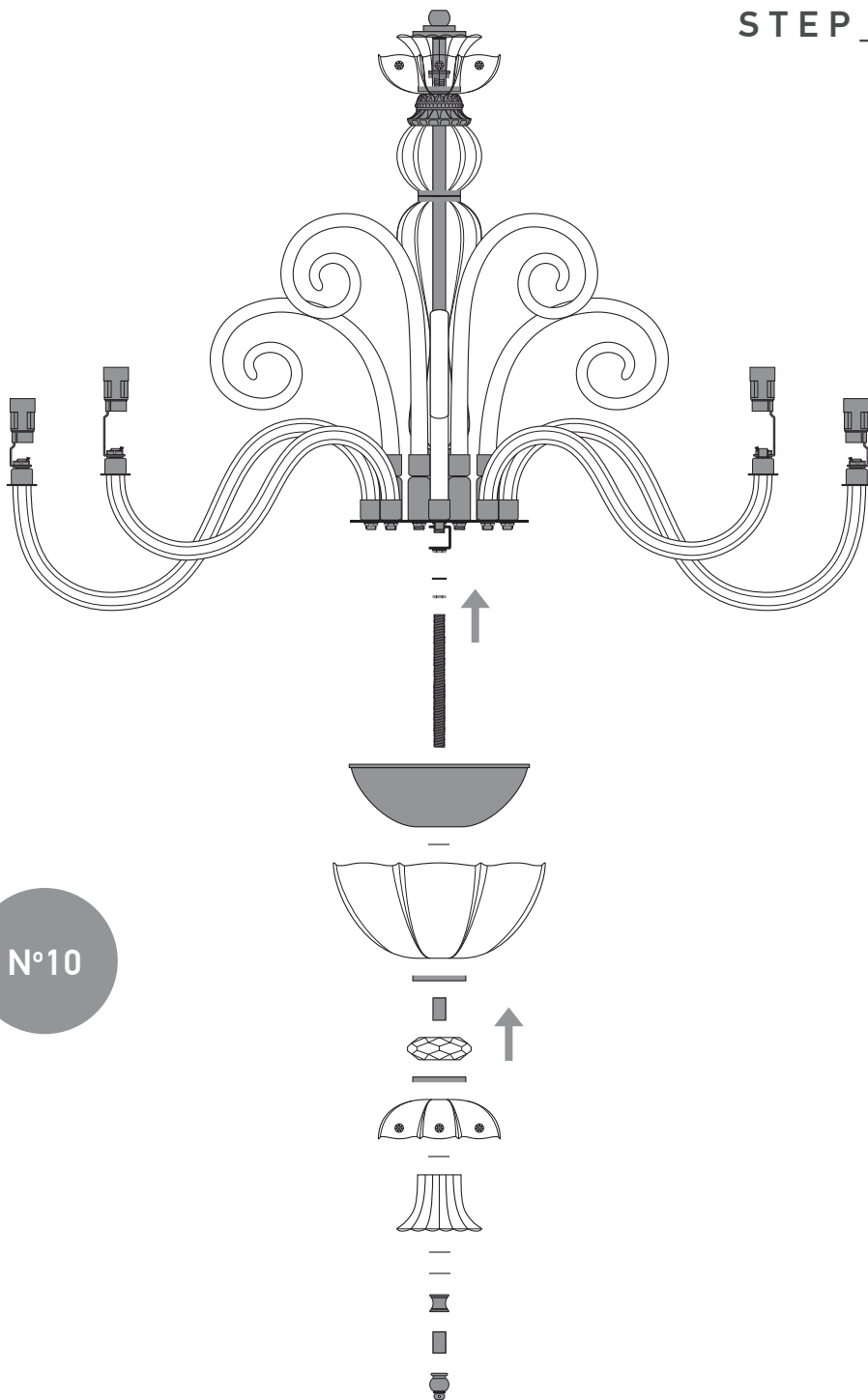

N°10

STEP_5

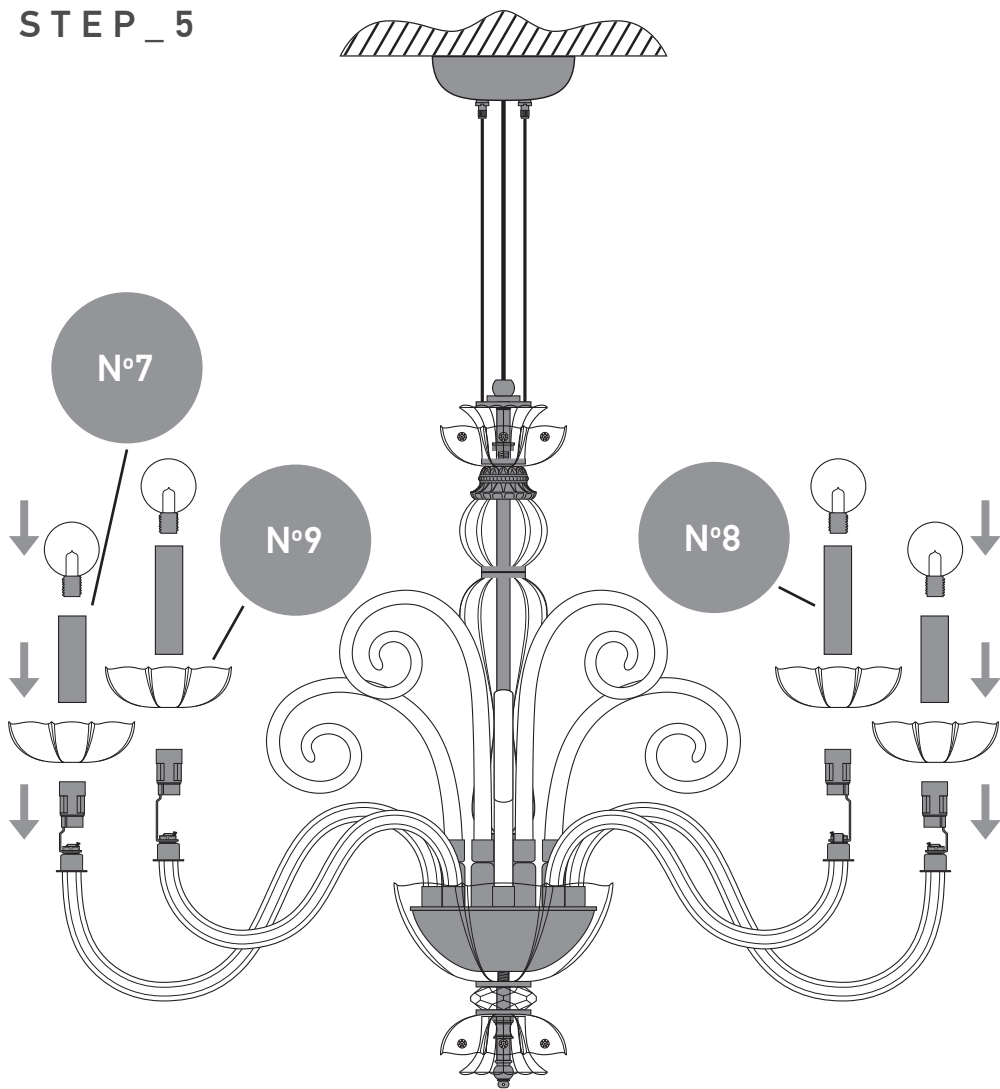

DECORATION TRIMMINGS VIEW

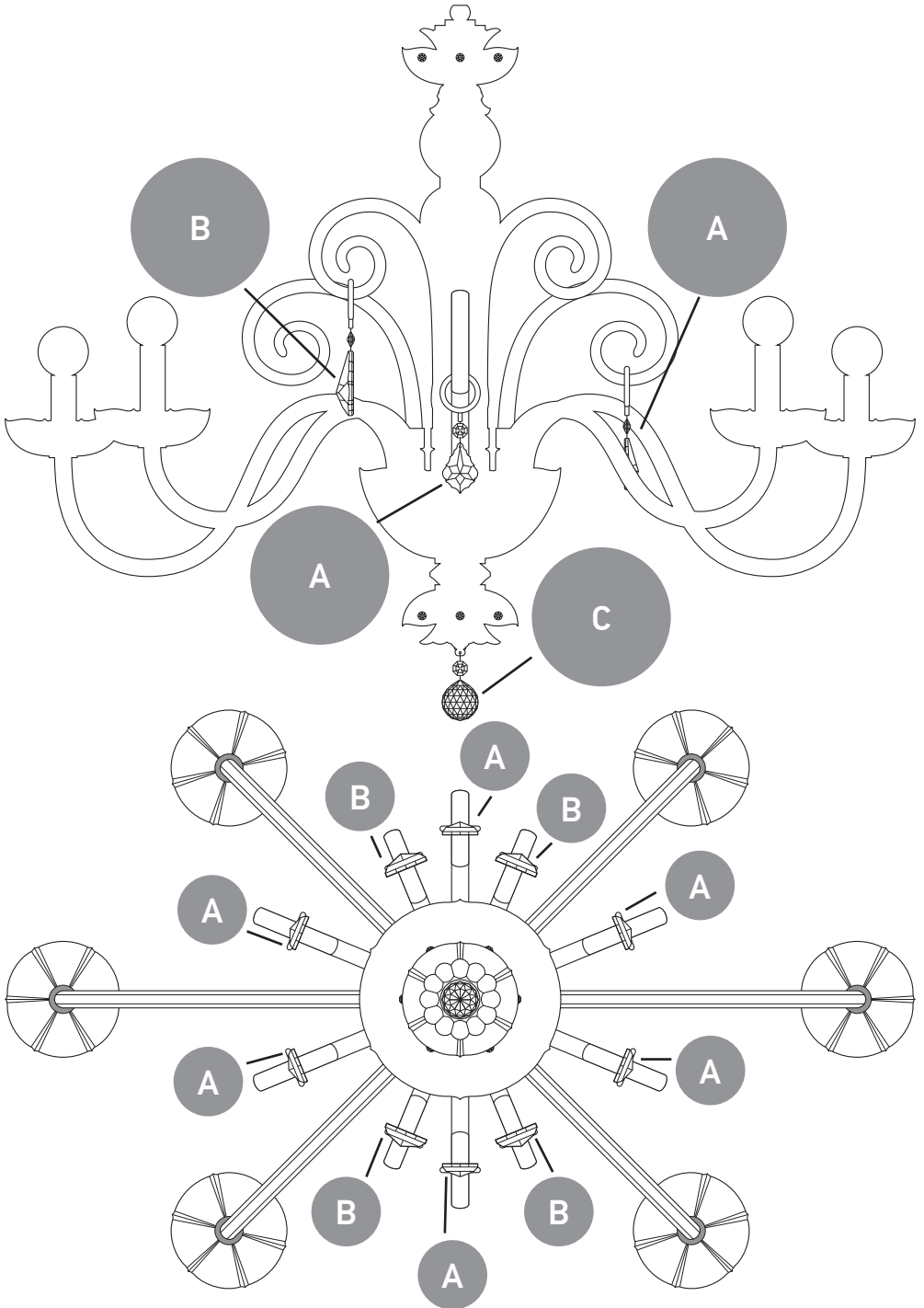



MADE IN
GREECE

11 Karditsis str, 42100

T +30 2431 0 76646

info@grandoluce.com

Trikala, Greece

F +30 2431 0 76696

www.grandoluce.com