



JULIANA

108_CH_8
Assembly Instructions

Assembly Steps



CH 8

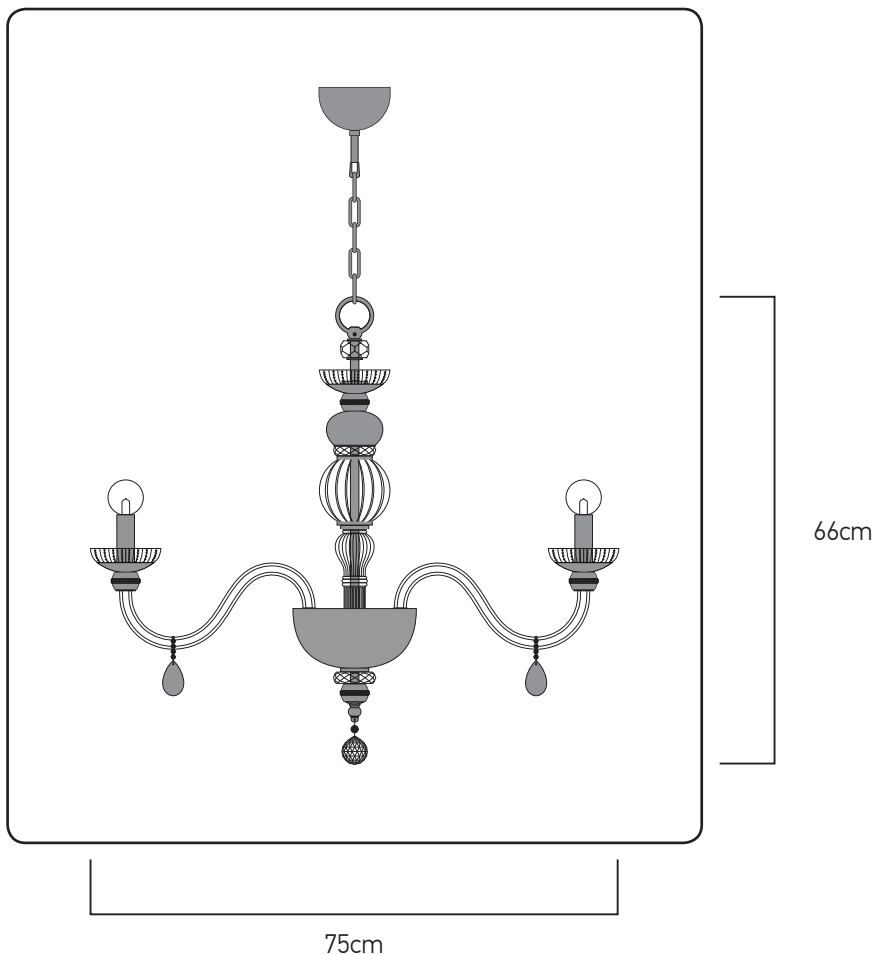

JULIANA_CH 8

parts_components

N°1 x 1

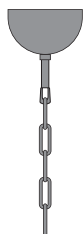

N°2 x 1

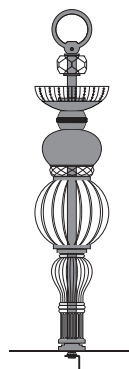

N°3 x 8

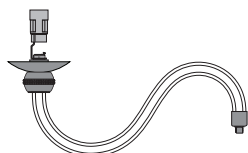

N°4 x 1

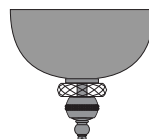

N°5 x 8



N°6 x 8



A x 8



B x 1



reference

lamps

lamp Watt Max

A.C

108/CH 8

8 x E14

42 Watt

230V - 50Hz



ΗΜΕΡΟΜΗΝΙΑ ΕΛΕΓΧΟΥ
TESTING DATE

..... / /

ΥΠΟΓΡΑΦΗ ΕΛΕΓΚΤΗ
TEST OPERATOR



DO NOT ASSEMBLE ANY GLASS PARTS THAT PRESENT CRACKS OR ANY OTHER DAMAGE CAUSED BY CARRIAGE OR WRONG PLACEMENT. A CAREFUL CHECK IS SUGGESTED. CLEAN WITH SOFT CLOTH OR MILD RISING AGENT WITH LOW TEMPERATURE WATER.
ΜΗ ΣΥΝΑΡΜΟΛΟΓΕΙΤΕ ΓΥΑΛΙΝΑ ΜΕΡΗ ΠΟΥ ΦΕΡΟΥΝ ΡΩΓΜΕΣ Ή ΑΛΛΕΣ ΖΗΜΙΕΣ ΑΠΟ ΜΕΤΑΦΟΡΑ Ή ΛΑΘΟΣ ΤΟΠΟΘΕΤΗΣΗ. ΚΑΘΑΡΙΣΤΕ ΜΕ ΜΑΛΛΑΚΟ ΠΑΝΙ Ή ΜΕ ΗΠΙΟ ΚΑΘΑΡΙΣΤΙΚΟ ΜΕ ΝΕΡΟ ΣΕ ΧΑΜΗΛΗ ΘΕΡΜΟΚΡΑΣΙΑ.

THIS DESIGN IS PROPERTY OF GRANDO LUCE AND IT IS FORBIDDEN TO COPY ANY PART OF THE DESIGN
ΑΥΤΟ ΤΟ ΣΧΕΔΙΟ ΕΙΝΑΙ ΙΔΙΟΚΤΗΣΙΑ ΤΗΣ GRANDO LUCE ΚΑΙ ΑΠΑΓΟΡΕΥΕΤΑΙ ΑΥΣΤΗΡΩΣ Η ΑΝΤΙΓΡΑΦΗ ΟΛΟΥ Ή ΜΕΡΟΥΣ ΑΥΤΟΥ

STEP_1

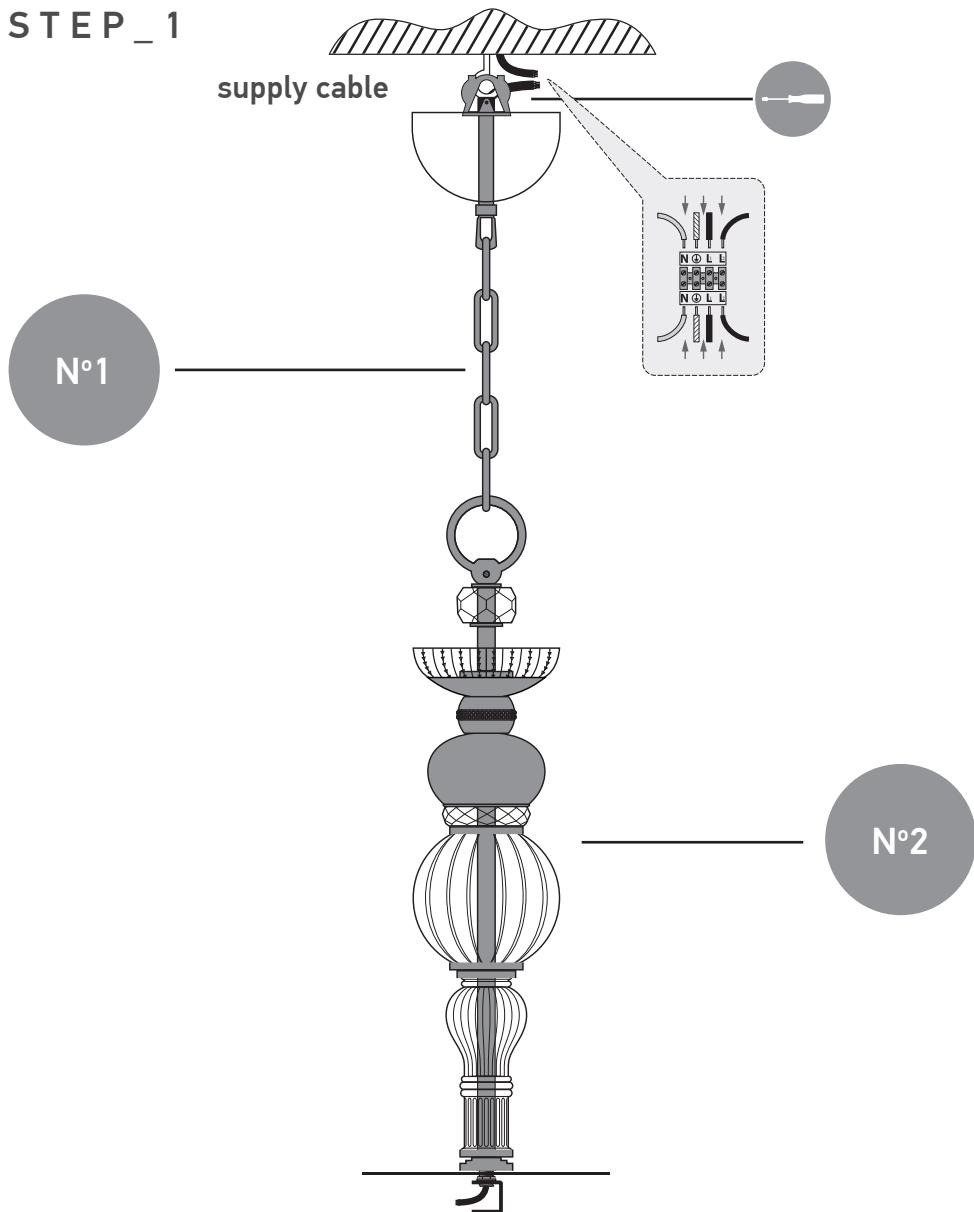

WARNING: fix the marked screws in the safety locking

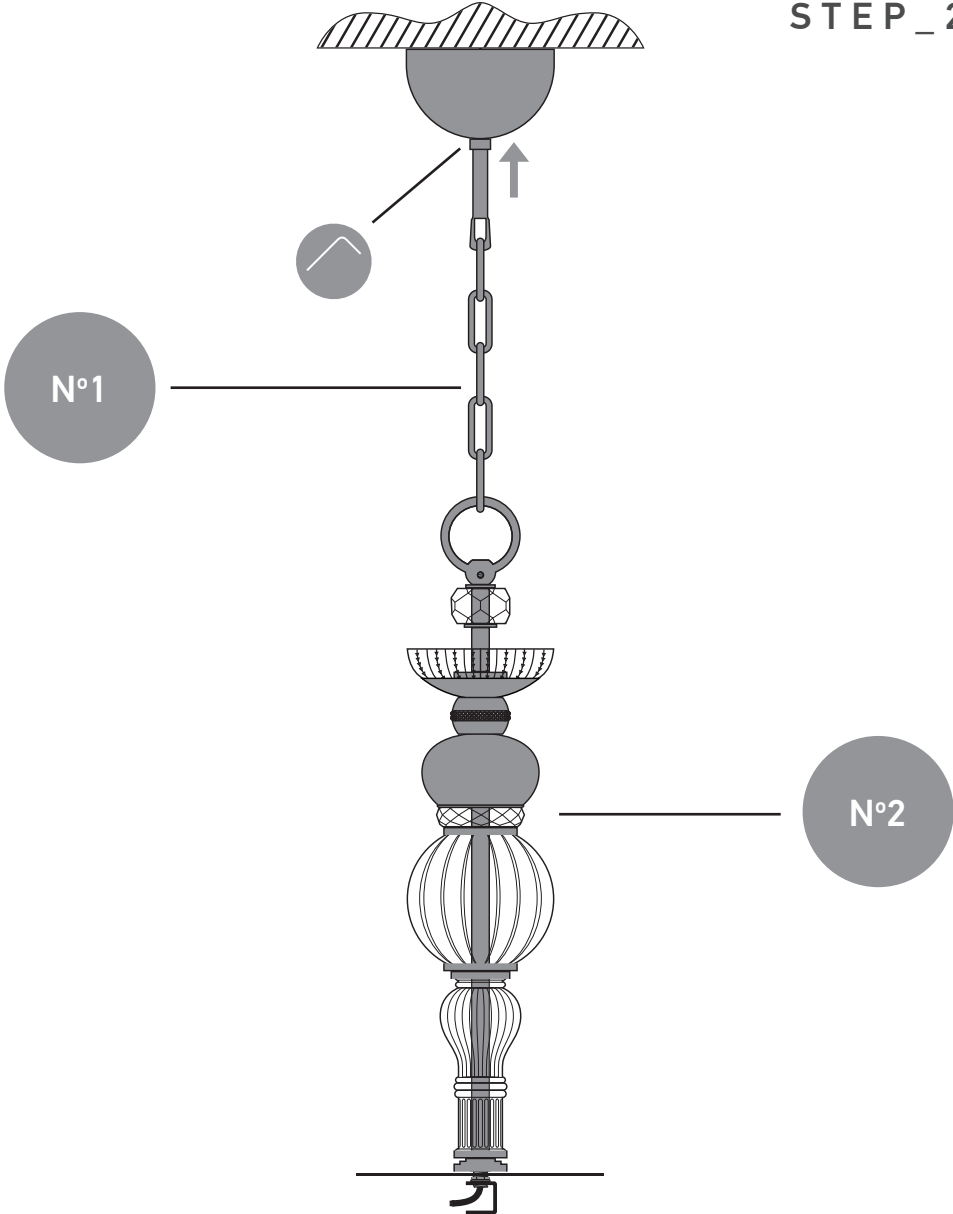

STEP_3

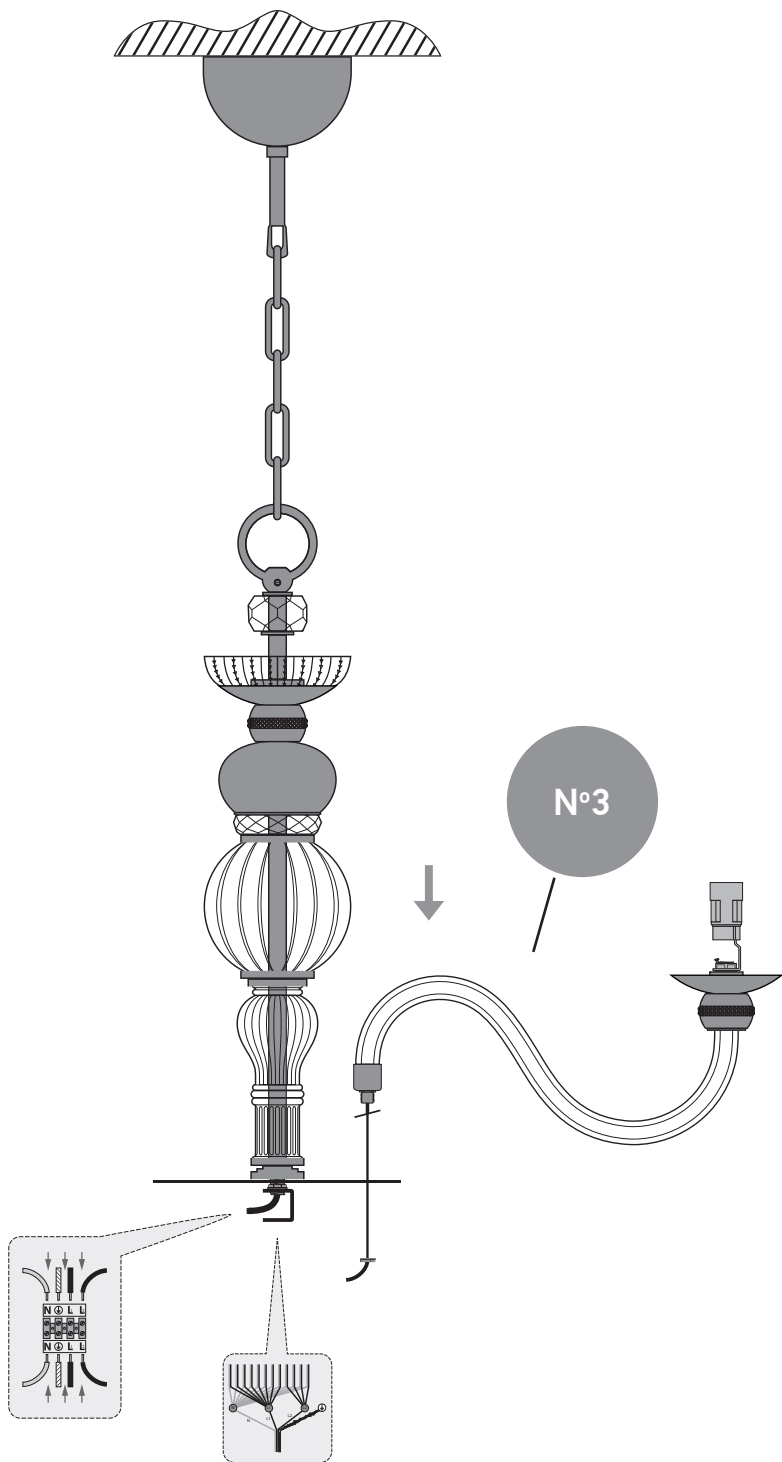

STEP_4

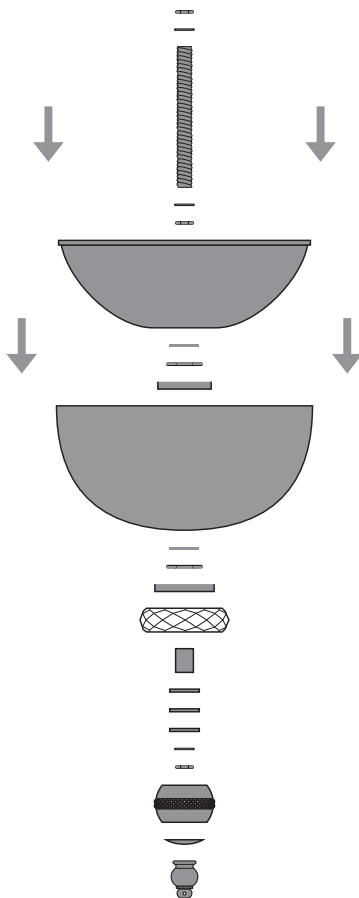
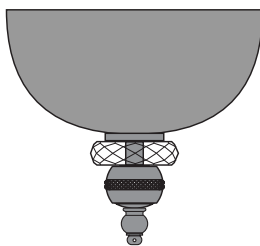

N°4

STEP_5

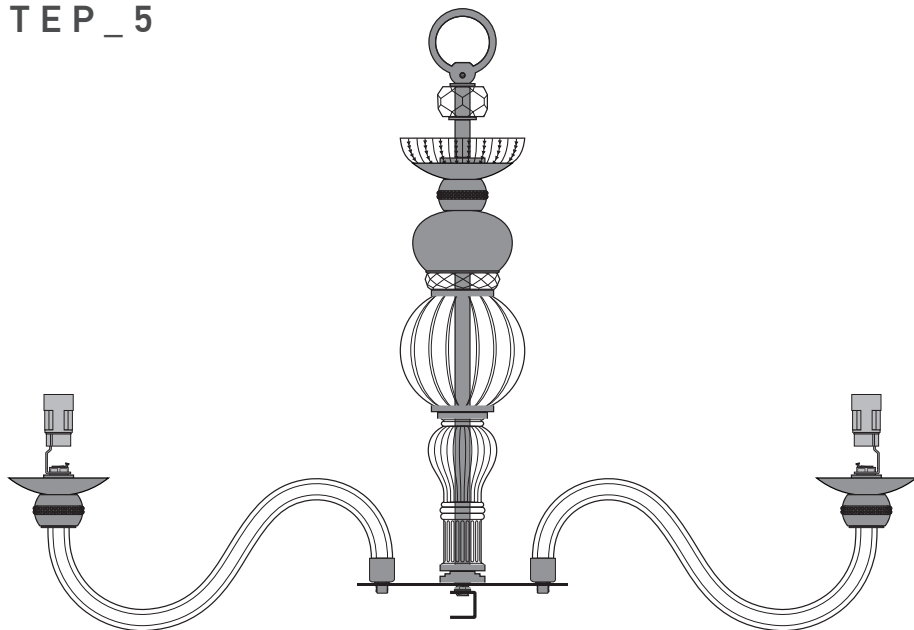

N°4

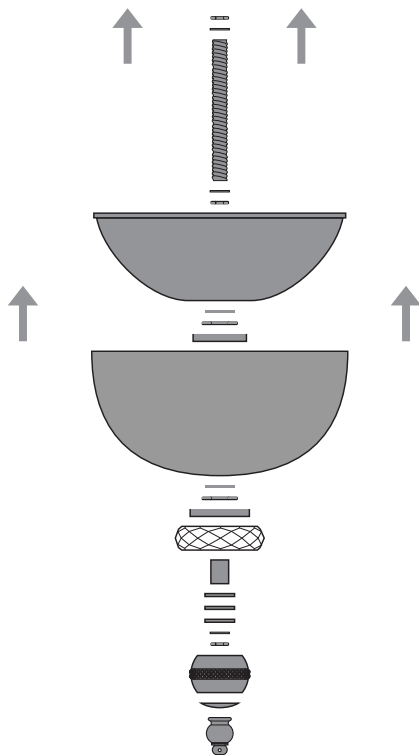

STEP_6

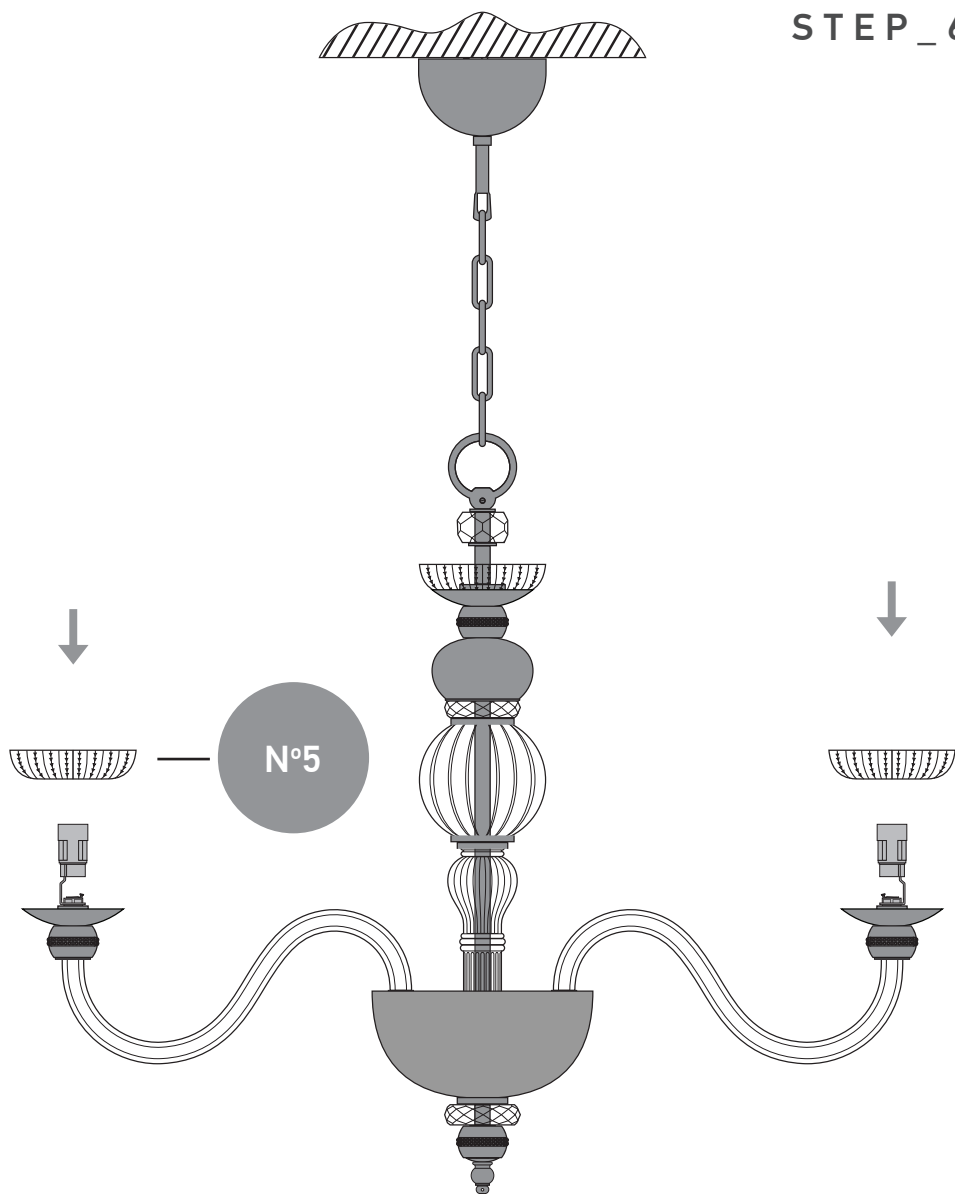

STEP_7

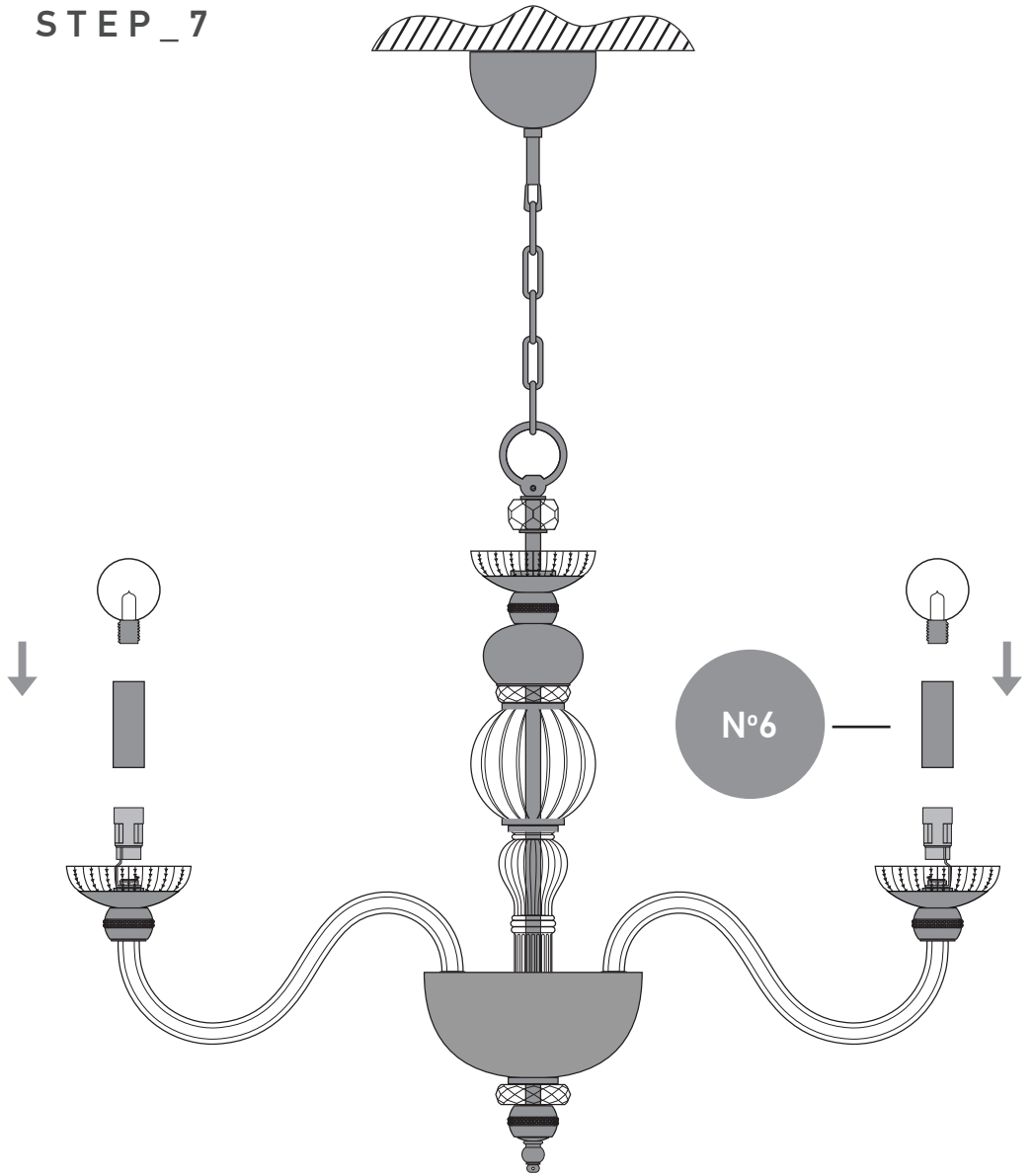

DECORATION TRIMMINGS VIEW

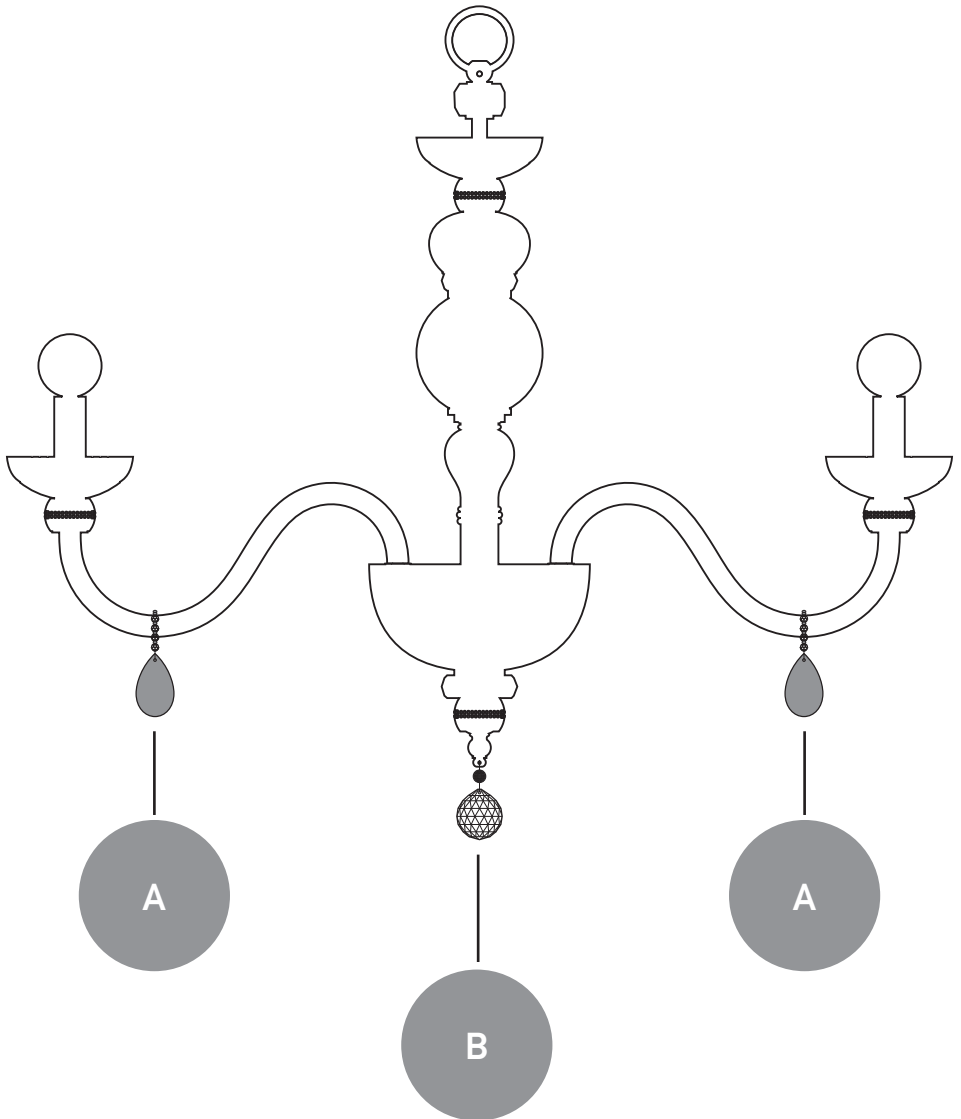



**MADE IN
GREECE**

11 Karditsis str, 42100
T +30 24310 76646
info@grandoluce.com

Trikala, Greece
F +30 24310 76696
www.grandoluce.com